

## Overview

- Excellent repeatability
- Dead band adjustment for regulation
- Fix dead band for control
- Overpressure up to 100 bar



Picture similar

## Technical data

### Housing

Protection rating (EN60529)	IP66
Cover	Blue painted, zamak Captive stainless steel screws
Case material	Black painted, zamak
Mounting	Wall mounting bracket
Scale	Internal, accuracy on reading $\pm 5\%$ FS

### Performance

Min. pressure range	0.2 ... 4 bar
Max. pressure range	5 ... 50 bar
Repeatability	$\pm 1\%$ FS

### Temperature

Ambient temperature	-25°C ... +55°C
---------------------	-----------------

### Temperature

Storage temperature	-40°C ... +70°C
Media temperature	-50°C ... +200°C

### Wetted parts

Process connection material	Stainless steel 1.4404 / AISI 316L
Diaphragm	Stainless steel 1.4404 / AISI 316L

### Electrical data

Electrical connection	Via internal terminal block with plastic cable gland for $\varnothing 7$ to 10.5 mm
Ground connection	Via internal terminal block
Adjustment	2 external adjustment screws on top of the case for set point and deadband

### Approval / Conformities

CE conformity	Low Voltage Directive 2014/35/UE
---------------	----------------------------------

## Remarks

- These devices must be used as instruments that provide electrical information according to the value of the input variable. They are not intended to be used as a safety accessory. It is the responsibility of the user to check the compatibility of the device with its intended use.

**Dimensional drawings (mm)**

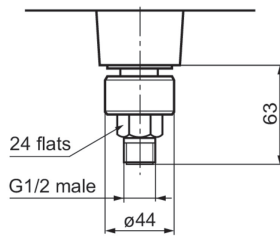
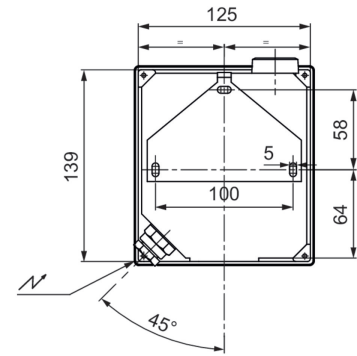
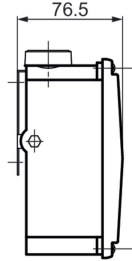
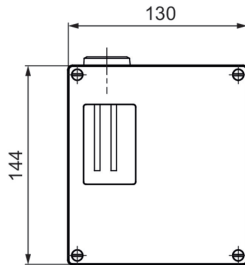

Pressure range codes: 204 - 205 - 206 - 210

Weight: 0.5 kg

**Electrical connection**

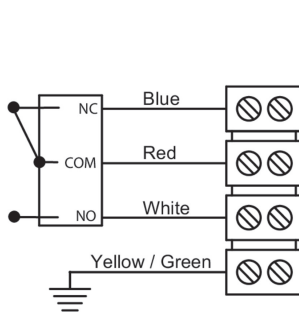

1 SPDT

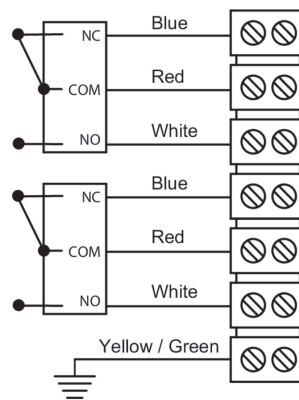

2 SPDT

**Principle**

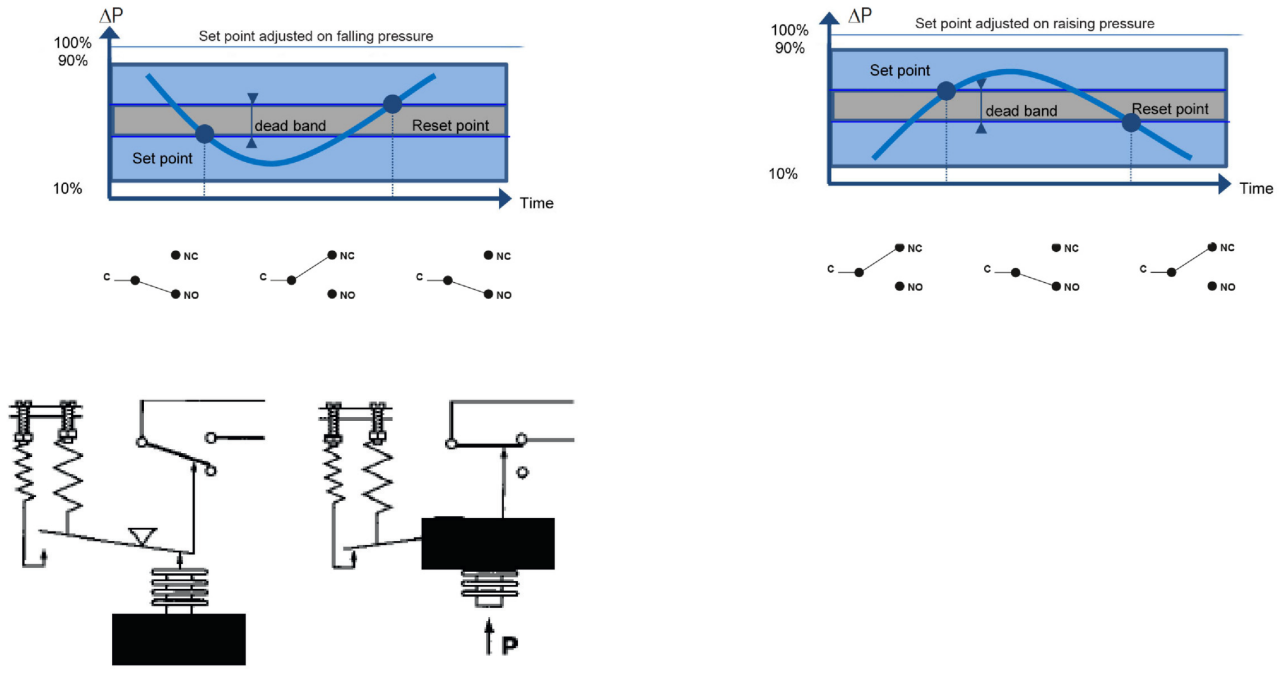

A flexible sensing element actuates a microswitch by means of a lever. The set point is adjusted by means of a compressible spring installed in opposition.

Set point and reset point must be between 10% and 90% of the selected scale.

Standard factory adjustment

Setpoint at 50% of the scale on falling pressure.

Customer specific factory adjustment (option SETP)

The following specifications have to be given with the order:

- Setpoint value
- Adjustment on falling or raising pressure
- Deadband value (as needed) when using an adjustable dead band switch

**Adjustable ranges**

Scale	P. Max accidental	Code	Micro-switch dead band <sup>*)</sup>									
			Adjustable dead band				Fixed dead band					
			A (B*)		M (K*)		C (W*)		E (F*)		H D (V*) J	
			10%	90%	10%	90%	10%	90%	10%	90%	10%	90%
bar	bar		bar				mbar		bar			
0.5 ... 10	50	204	0.3 - 3	0.55 - 3	0.63 - 3	0.80 - 3	45	62	0.25	0.3		
3.5 ... 25	100	205	0.45 - 10	0.9 - 10	1.5 - 10	3.1 - 10	150	200	0.55	1.1		
5 ... 50	100	206	1 - 10	2 - 10	3.5 - 10	7 - 10	200	300	1.5	2.5		
0.2 ... 4	50	210	0.1 - 3	0.18 - 3	0.35 - 3	0.63 - 3	40	50	0.15	0.25		

(\*) When using 2 microswitches deadband lower values should be x1.5

1) The value of the deadband is depending on the value of the set point. This table contains the deadband values for set point adjustment at 10% and 90% of the selected scale. For adjustable deadband the lower value corresponds to the deadband spring totally released and the higher corresponds to the deadband spring fully tensed. For other set points the deadband value can be calculated by linear interpolation between the values at 10% and 90%.

## Micro switch characteristics

Switch code	A (B)	M (K)	C (W)	E (F)	H	D (V)	J
Type	Standard	Gold contact	Hermetic	Ultra sensitive	Manual reset	Ultra sensitive Hermetic	Manual reset
6 Vdc	0.4 ... 10 A	10 ... 50 mA	5 mA ... 4 A	0.4 ... 1 A	N/A	0.4 ... 4 A	N/A
12 Vdc	0.4 ... 10 A	10 ... 50 mA	5 mA ... 4 A	0.4 ... 1 A	N/A	0.4 ... 4 A	N/A
24 Vdc	0.4 ... 6 A	10 ... 50 mA	5 mA ... 4 A	0.4 ... 1 A	0.1 ... 8 A	0.4 ... 4 A	0.1 ... 8 A
30 Vdc	0.4 ... 6 A	10 ... 50 mA	5 mA ... 3 A	0.4 ... 1 A	0.1 ... 8 A	0.4 ... 2 A	0.1 ... 8 A
48 Vdc	0.4 ... 6 A	10 ... 50 mA	5 mA ... 3 A	N/A	N/A	N/A	N/A
110 Vdc	0.1 ... 0.5 A	10 ... 50 mA	5 mA ... 1 A	N/A	N/A	N/A	N/A
220 Vdc	0.1 ... 0.25 A	10 ... 50 mA	5 mA ... 0.5 A	N/A	N/A	N/A	N/A
115 Vac	0.4 ... 10 A	10 ... 50 mA	50 mA ... 3 A	0.4 ... 10 A	0.1 ... 10 A	N/A	0.1 ... 10 A
250 Vac	0.4 ... 10 A	N/A	50 mA ... 2.5 A	0.2 ... 10 A	0.1 ... 5 A	N/A	0.1 ... 5 A
Dielectric rigidity between contacts and ground	2000 V	2000 V	1500 V	2000 V	2000 V	1000 V	2000 V

## Ordering reference

Ordering key - Configuration possibilities see website

	RPPN	-	8	#	#	.	###
<b>Product</b>	RPPN						
<b>Sensing element</b>	Diaphragm:St.steel		8				
<b>Type of Microswitch</b>	1xSPDT, Standard			A			
	simultaneous			B			
	1xSPDT, hermetically			C			
	simultaneous			W			
	1xSPDT, ultra sensitive			E			
	simultaneous			F			
	1xSPDT hermetic/ultra sensit.?			D			
	simultaneous			V			
	1 gold contact changeover switch			M			
	simultaneous			K			
	1xSPDT, manually, falling			H			
	1xSPDT, manually, rising			J			
	Pneumatic type, NC			Y			
	Pneumatic type, NO			Z			
<b>Process connection</b>	G 1/2						3
	1/2 NPT						6
	1/4 NPT F						8
<b>Pressure range</b>	0,5 ... 10 bar						204
	3,5 ... 25 bar						205
	5 ... 50 bar						206
	0,2 ... 4 bar						210

## Ordering example

	RPPN	-	8	A	3	.	204	/	SETP
<b>Product</b>	RPPN								
<b>Sensing element</b>	Diaphragm:St.steel		8						
<b>Type of Microswitch</b>	1xSPDT, Standard			A					
<b>Process connection</b>	G 1/2				3				
<b>Pressure range</b>	0,5 ... 10 bar						204		
<b>Adjustment</b>	Setpoint factory adjusted								SETP

## Options

Setpoint factory adjusted	SETP	Setpoint adjust. lead sealed	8990
For oxygen applications	0765	2.1 Certificate	Q001
Mounting on 2 pipe	0407	2.2 Certificate	Q002
Souriau connection	2298	3.1 Material certificate	Q003
Souriau mobile plug	2249	3.1 Certif. setpoints adjust.	Q011
stainless steel label wired*	9941		