

Overview

- Excellent repeatability
- Dead band adjustment for regulation
- Fix dead band for control
- Intrinsic safety Hazardous area 0, 1, 2
- Static pressure max. 20 bar
- No influence of the static pressure on the setpoint

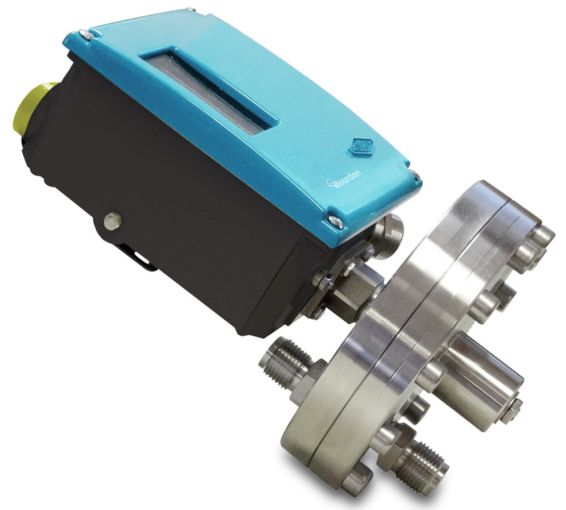

Picture similar



Technical data

Housing

Protection rating (EN60529)	IP66
Cover	Blue painted, zamak Captive stainless steel screws
Case material	Black painted, zamak
Mounting	Wall mounting bracket
Scale	Internal, accuracy on reading $\pm 5\%$ FS

Process

Process connection	G1/4" female, only for codes 161,162,163 G1/2" 1/4" NPT female 1/2" NPT
--------------------	--

Process connection material	Stainless steel 1.4404 / AISI 316L
-----------------------------	------------------------------------

Temperature

Ambient temperature	-25°C ... +55°C (T6)
Storage temperature	-40°C ... +70°C
Media temperature	-15°C ... +150°C

Wetted parts

Flange	Stainless steel 1.4404 / AISI 316L
Diaphragm	FKM (Viton)

Remarks

- These devices must be used as instruments that provide electrical information according to the value of the input variable. They are not intended to be used as a safety accessory. It is the responsibility of the user to check the compatibility of the device with its intended use.

Sensing / Input

Min. measuring range	10 ... 200 mbar
Max. measuring range	10 ... 2000 mbar

Performance

Repeatability	$\pm 1\%$ FS
Adjustment	2 external adjustment screws on top of the case for set point and deadband The adjustment is not influenced by changes of the static pressure

Electrical data

Ground connection	Via internal terminal block
Electrical connection	Via internal terminal block with plastic cable gland for $\varnothing 7$ to 10.5 mm

Approval / Conformities

ATEX/IECEX Certificate	LCIE 03 ATEX 6123X IECEX LCIE 15.0060X
ATEX/IECEX	Ex I M1 Ex II 1 G Further information can be found in the ATEX approval
CE conformity	ATEX directive 2014/34/UE

Dimensional drawings (mm)

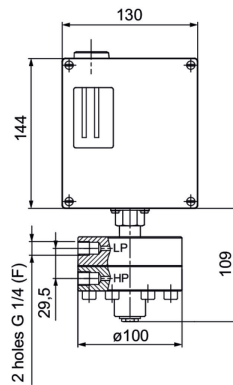
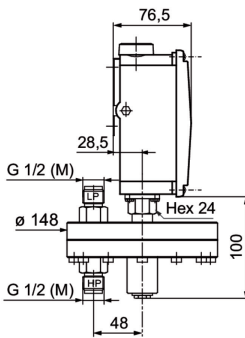
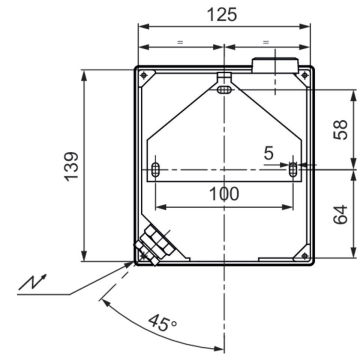
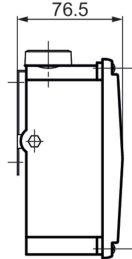
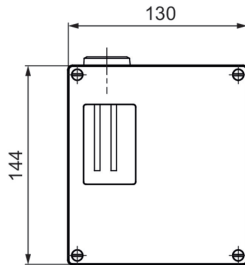

Pressure range codes: 156 - 157 - 158
Weight: 6.6 kg

Pressure range codes: 161 - 162 - 163
Weight: 7 kg

Electrical connection

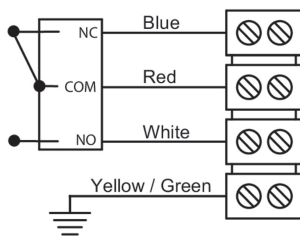

1 SPDT

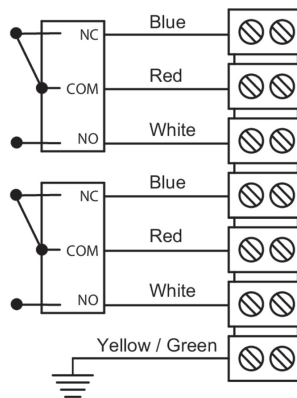

2 SPDT

Electrical connection

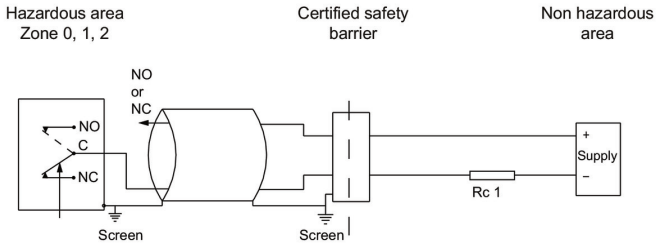

For max. ambient temperature according to temperature classes T5 and T6 refer to technical data.

The installation must be made in an intrinsically safe circuit whose certified electrical safety parameters do not exceed any of the values U_{max} , I_{max} and P_{max} given in the electrical data.

All necessary measures must be taken by the user, to avoid the calorific transfer from the fluid to the apparatus head increasing the head's temperature to such that it reaches the self-ignition temperature of the gas in which it is used.

Principle

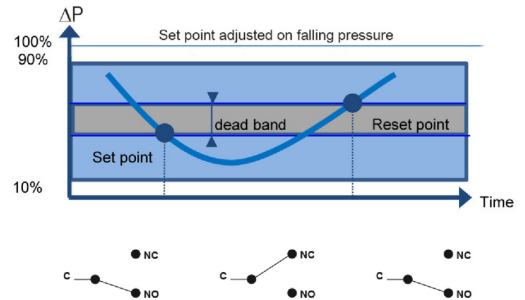
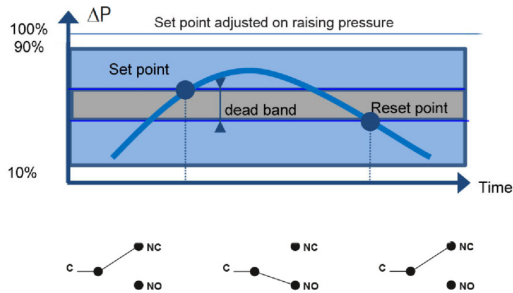

RDY6

Differential pressure switch with intrinsic safety for variable static pressure

RDY-###.###/

Principle

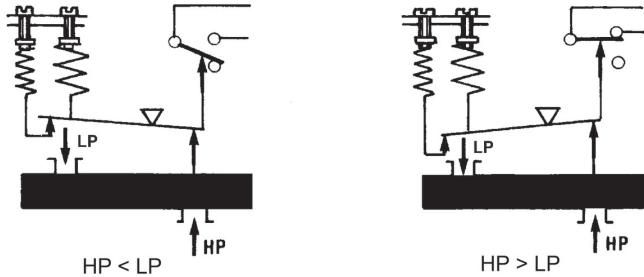

A flexible sensing element actuates a microswitch by means of a piston. The set point is adjusted by means of a compressible spring installed in opposition.

Set point and reset point must be between 10% and 90% of the selected scale.

Standard factory adjustment

Setpoint at 50% of the scale on falling pressure.

Customer specific factory adjustment (option SETP)

The following specifications have to be given with the order:

- Setpoint value
- Adjustment on falling or raising pressure
- Static pressure (except RDx6)
- Dead band value (as needed) when using an adjustable dead band switch

Adjustable ranges

Scale	Max ΔP	Max P Static	Code	Micro-switch dead band ^o					
				Adjustable dead band				Fixed dead band	
				M (K [*])		C(W [*])		S	
				10%	90%	10%	90%	10%	90%
mbar	mbar	bar		mbar					
10 ... 200	200	20	156	8 - 80	10.5 - 80	35 - 80	45 - 80	5.8	9.5
10 ... 400	400	20	157	15 - 150	20 - 150	40 - 150	50 - 150	10.5	17
10 ... 1000	1000	20	158	18 - 150	22 - 150	45 - 150	60 - 150	11.5	19.6
10 ... 700	700	20	161 ^{**}	30 - 250	45 - 250	130 - 450	150 - 450	27.5	34
10 ... 1500	1500	20	162 ^{**}	30 - 300	45 - 300	130 - 450	150 - 450	27.5	34
10 ... 2000	2000	20	163 ^{**}	45 - 300	90 - 300	180 - 450	300 - 450	31	50

(*) For version with 2 microswitches lower values of the dead band must be multiplied x 1.5

(**) G1/4 female only

(1) The value of the dead band is depending on the value of the set point. This table contains the dead band values for set point adjustment at 10% and 90% of the selected scale. For adjustable dead band the lower value corresponds to the dead band spring totally released and the higher corresponds to the dead band spring fully tensed. For other set points the dead band value can be calculated by linear interpolation between the values at 10% and 90%.

RDY6

Differential pressure switch with intrinsic safety for variable static pressure

RDY-###.###/

Micro switch characteristics

Switch code	M (K)	C (W)	S
Type	Gold contact	Hermetic	Ultrasensitive Gold contact
6 Vdc	10 ... 50 mA	5 ... 120 mA	10 ... 50 mA
12 Vdc	10 ... 50 mA	5 ... 120 mA	10 ... 50 mA
24 Vdc	10 ... 50 mA	5 ... 120 mA	10 ... 50 mA
30 Vdc	N/A	N/A	N/A
48 Vdc	N/A	N/A	N/A
110 Vdc	N/A	N/A	N/A
220 Vdc	N/A	N/A	N/A
115 Vac	N/A	N/A	N/A
250 Vac	N/A	N/A	N/A
Dielectric rigidity between contacts and ground	2000 V	1500 V	2000 V

RDY6

Differential pressure switch with intrinsic safety for variable static pressure

RDY-###.###/

Ordering reference

Ordering key - Configuration possibilities see website

	RDY	-	6	#	#	.	###
Product	RDY						
Measuring element							
Membran, Viton® (≤ 2 bar)			6				
Type of Microswitch							
1xSPDT, hermetically						C	
simultaneous						W	
1 gold contact changeover switch						M	
simultaneous						K	
1xSPDT, gold, ultra sensitive						S	
Process connection							
G 1/4 Internal Screw							H
G 1/2							3
1/2 NPT							6
1/4 NPT F							8
Pressure range							
10 ... 200 mbar							156
10 ... 400 mbar							157
10 ... 1000 mbar							158
10 ... 700 mbar							161
10 ... 1500 mbar							162
10 ... 2000 mbar							163

Ordering example

	RDY	-	6	C	H	.	161	/	0765
Product	RDY								
Measuring element									
Membran, Viton® (≤ 2 bar)			6						
Type of Microswitch									
1xSPDT, hermetically				C					
Process connection									
G 1/4 Internal Screw					H				
Pressure range									
10 ... 700 mbar							161		
Cleanliness									
for oxygen applications									0765
free of oil and grease									

RDY6

Differential pressure switch with intrinsic safety for variable static pressure

RDY-###.###/

Options

Setpoint factory adjusted	SETP	Souriau connection	2298
For oxygen applications	0765	2.1 Certificate	Q001
Mounting on 2 pipe	0407	2.2 Certificate	Q002
stainless steel label wired*	9941	3.1 Material certificate	Q003
Setpoint adjust. lead sealed	8990	3.1 Certif. setpoints adjust.	Q011
Souriau mobile plug	2249		